

# *Tuff-Rib<sup>®</sup> Panel*

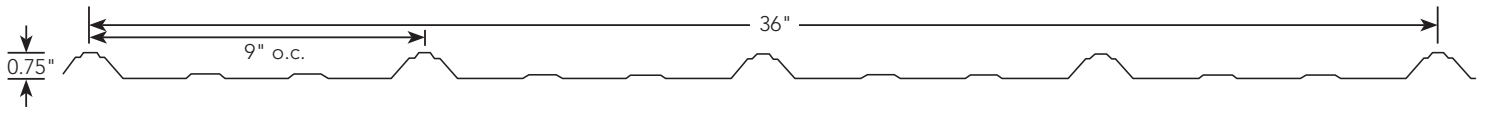

# *5-V Panel*

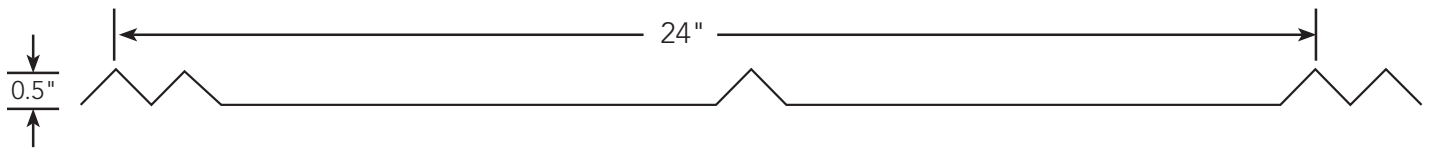

# *R-Panel*

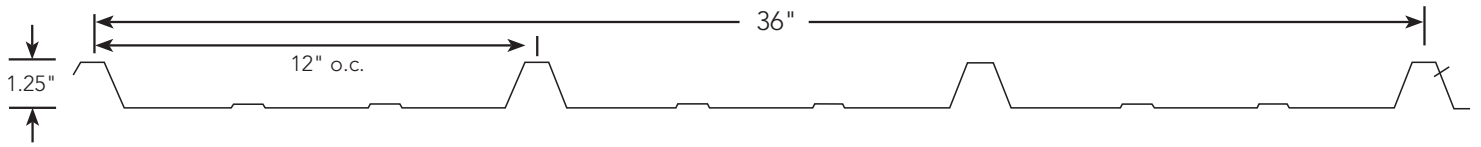

# Snaploc Standing Seam Panels

*Screw Flange Panel*

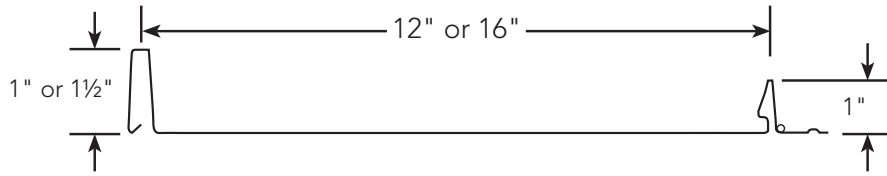

*Clip Panel*

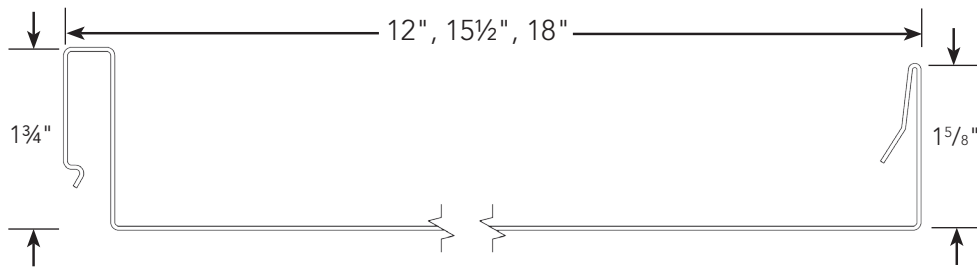

## CHOOSE YOUR PAN STYLE



Pencil Rib



Striations

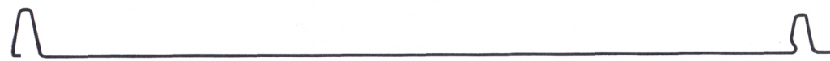

Flat

# Tuff-Rib<sup>®</sup>/5-V Trims

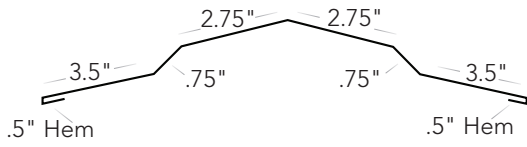

Ridge Cap  
#T-RC

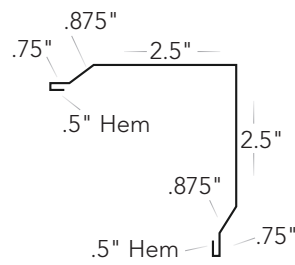

Narrow Outside  
Corner  
#T-OCN

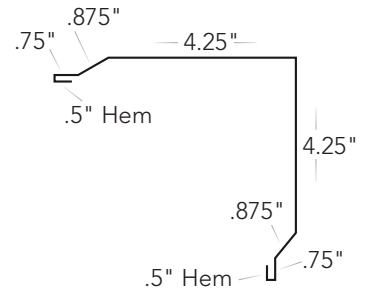

Wide Outside  
Corner  
#T-OCW

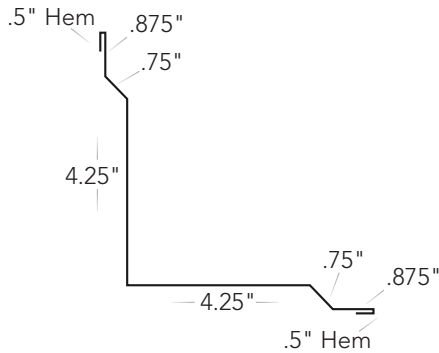

Inside Corner  
#T-IC

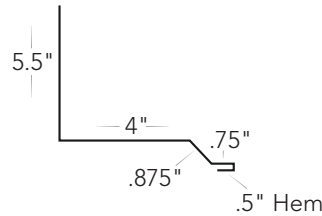

Sidewall  
#T-SW

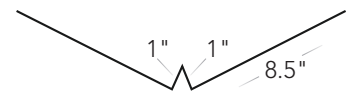

W Valley  
#T-WV

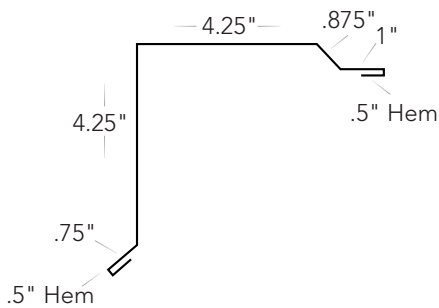

Rake & Gable  
#T-RNG

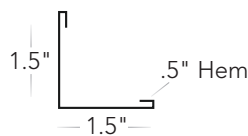

1.5" Angle  
#T-1.15A

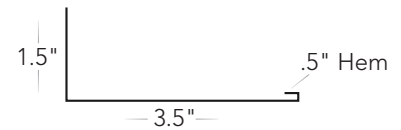

3.5" Angle  
#T-3.5A

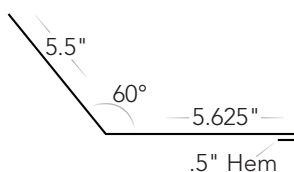

Endwall/Transition  
#T-EW

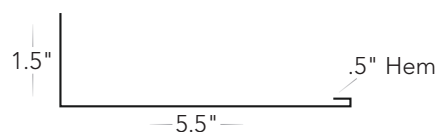

5.5" Angle  
#T-5.5A

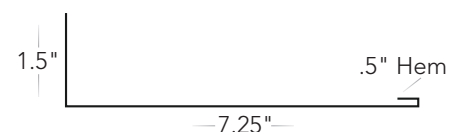

7.5" Angle  
#T-7.5A

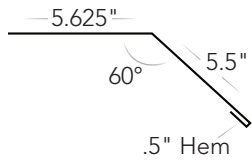

Gambrel Flashing  
#T-GF

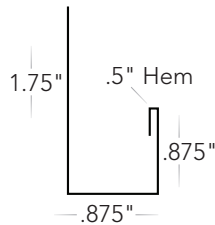

J-Channel  
#T-JC

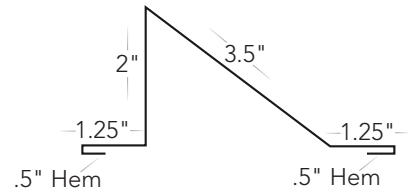

Carolina Snow  
Guard  
#T-CSG

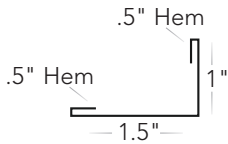

Snow Guard  
#T-SG

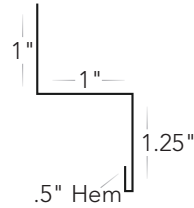

Wainscoat  
Trim  
#T-WT

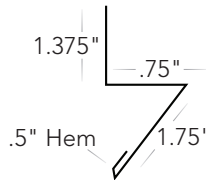

Rat Guard  
#T-RG

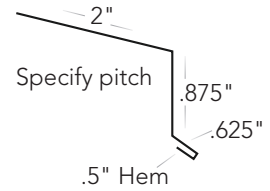

Drip Edge  
#T-DE

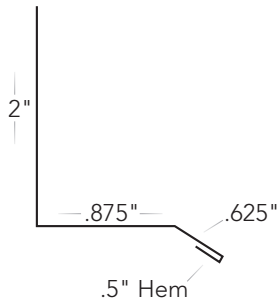

Drip Flashing  
#T-DF

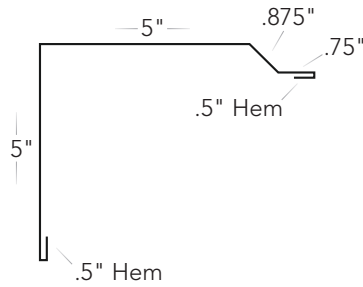

Wide Sliding  
Door  
#T-SD10

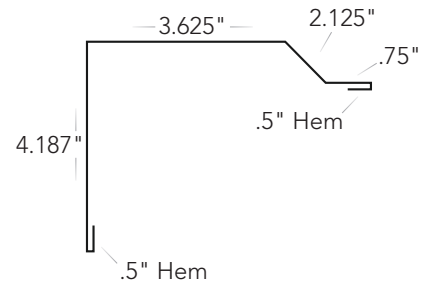

Narrow Sliding  
Door  
#T-SD5

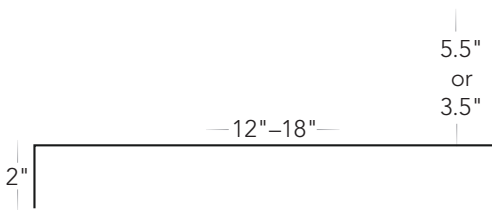

Soffit Trim  
#T-ST

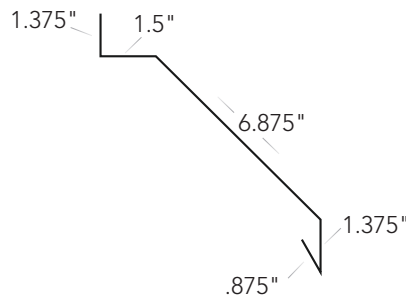

Round Door  
Track Cover  
#T-RDT

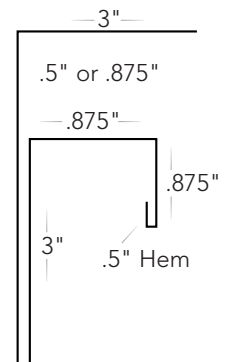

F-J Trim  
#T-FJ

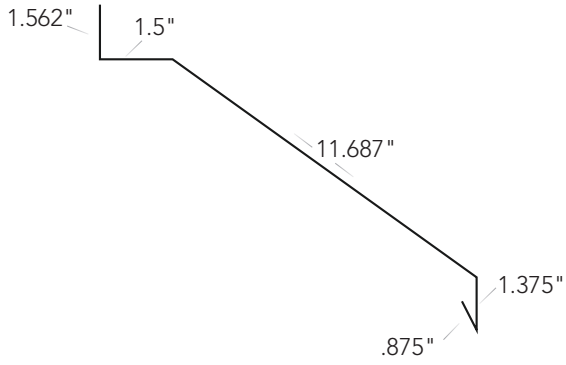

Double Round  
Door Track Cover  
#T-DRDT

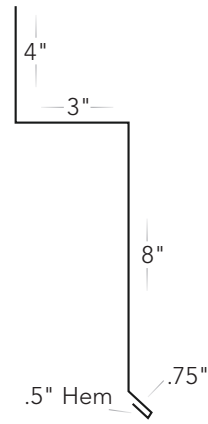

Square Door  
Track Cover  
#T-SDT

# R-Panel Trims

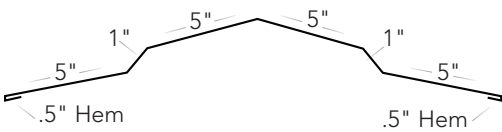

Ridge Cap  
#R-RC

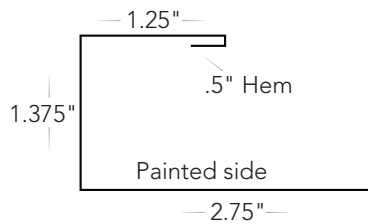

C-Channel  
#R-CC

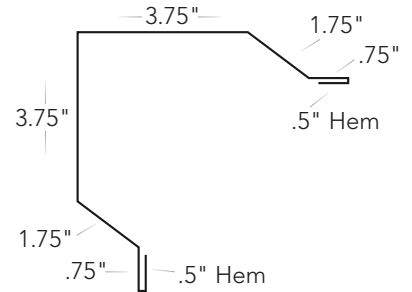

Outside  
Corner  
#R-OC

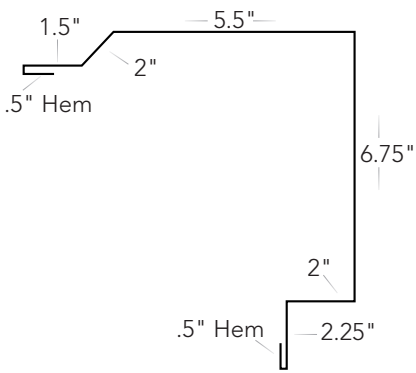

Rake  
#R-RT

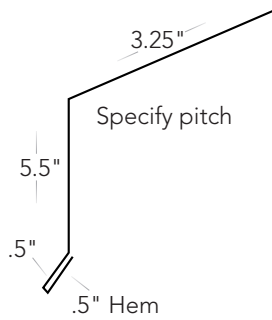

Eave  
#R-ET

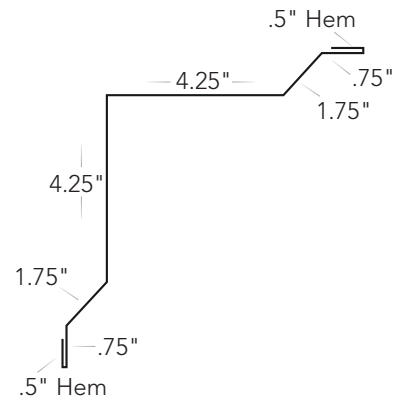

Inside Corner  
#R-IC

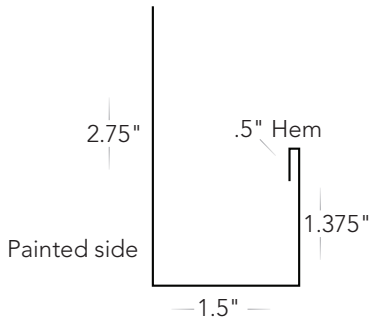

J-Channel  
#R-JC

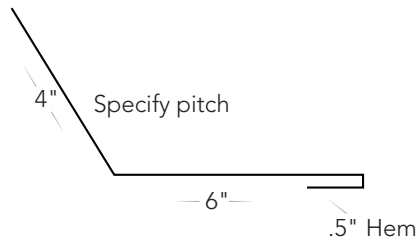

Endwall/Transition  
#R-EW

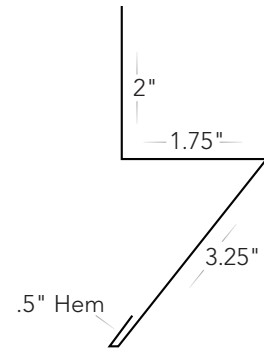

Rat Guard  
#R-RG

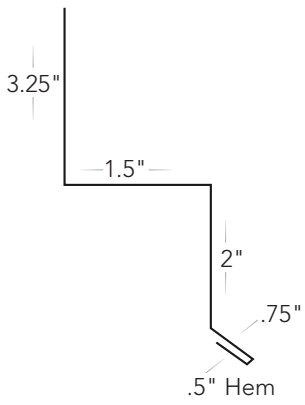

Wainscoat  
#R-WT

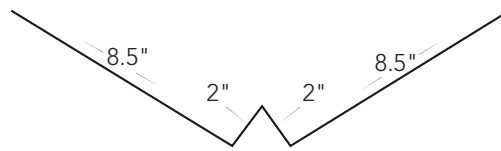

Valley  
#R-WV

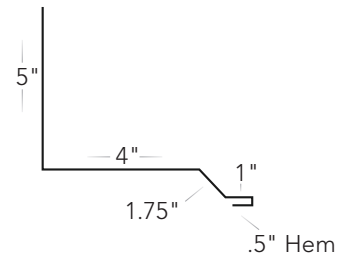

Sidewall  
#R-SW

# Snaploc Standing Seam Trims

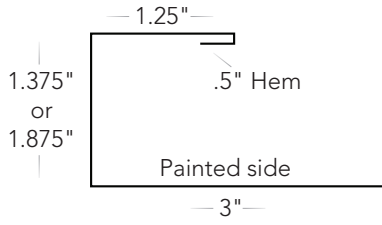

C-Channel  
#S-CC

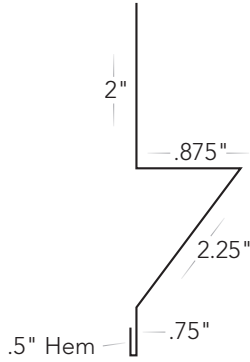

Reglet  
Flashing  
#S-RF

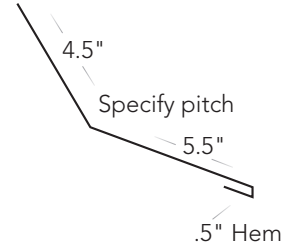

Endwall/Transition  
#S-EW

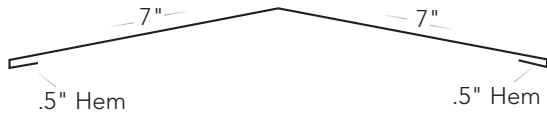

Ridge Cap  
#S-RC

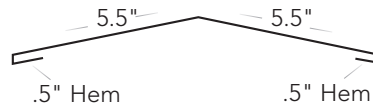

Hip Cap  
#S-HC

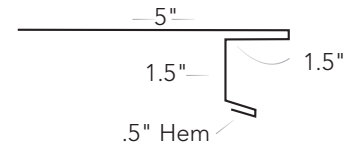

Extended Rake  
#S-ER

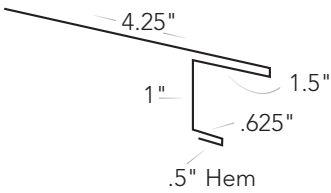

Extended Eave  
#S-EE

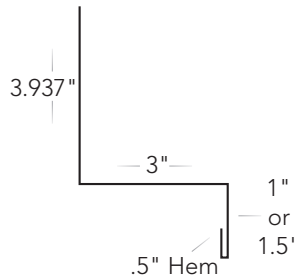

Sidewall  
#S-SW

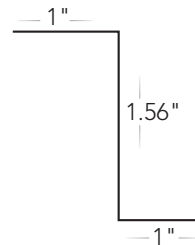

Z-Bar

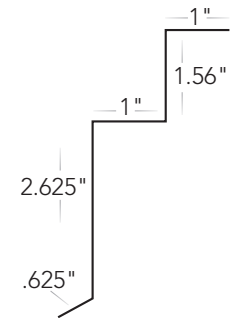

Z- Rake Cleat  
#S-ZRC

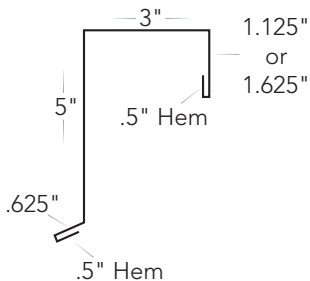

Rake  
#S-RT



Offset Cleat  
#S-OC

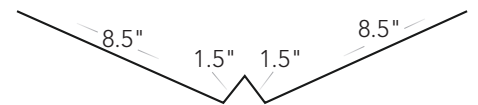

Valley  
#S-WV